

15FCX76

8Ω**Coaxials - 15.0 Inches**

- 800 W continuous program power capacity
- 80° nominal coverage
- 40 - 18000 Hz response
- 98 dB sensitivity
- 50.5 mm (2") HF unit exit diameter
- Single Ferrite magnet assembly
- Aluminium demodulating ring allows a very low distortion figure

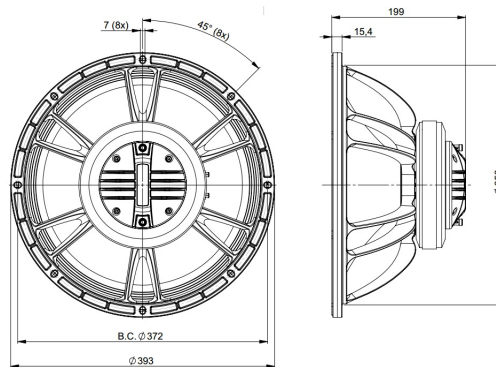

15FCX76

Coaxials- 15.0 Inches

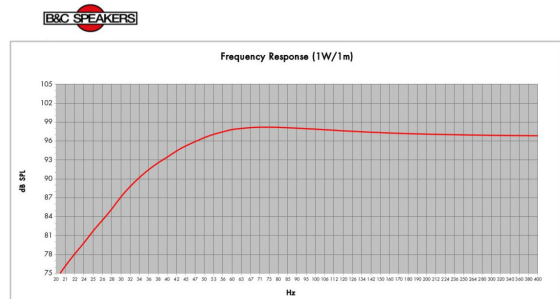
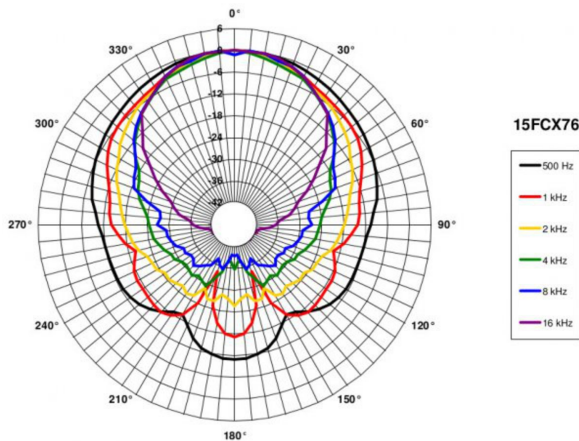
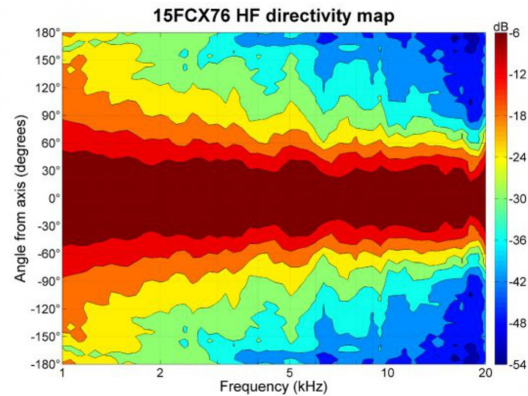
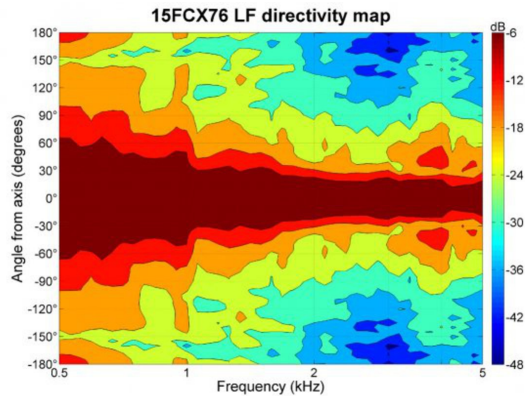
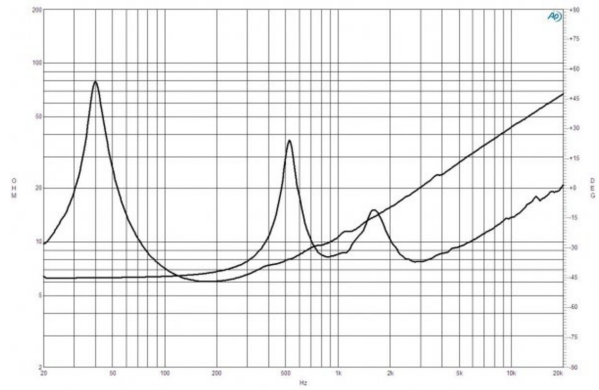
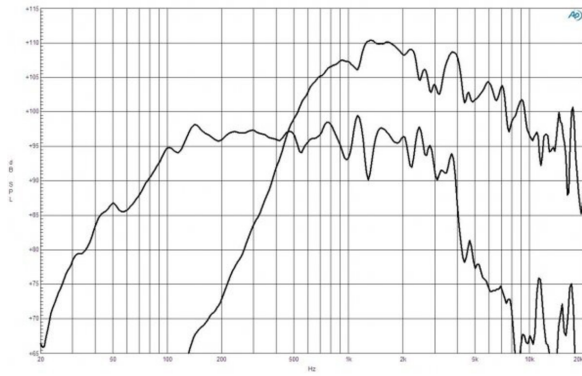

Model:	15FCX76	Configuration:	One Driver
Enclosure Type:	Box Reflex		
Internal Net Volume (liters):	160	Q _{ts} :	7
Tuning Frequency (Hz):	40	Port Area (cm ²):	277.5
Frequency (-3 dB) (Hz):	40.8	Port Length (cm):	16.1

SPECIFICATIONS

Nominal Diameter	380 mm (15.0 in)
Nominal Impedance	8 Ω
Minimum Impedance LF	6.0 Ω
Minimum Impedance HF	7.5 Ω
Frequency Range	40 - 18000 Hz
Dispersion Angle ¹	80 °
Woofer Cone Treatment	WP Waterproof Front Side
Magnet Material	Ferrite

SPECIFICATIONS LF UNIT

Sensitivity ²	98.0 dB
Nominal Power Handling ³	400 W
Continuous Power Handling ⁴	800 W
Voice Coil Diameter	76 mm (3.0 in)
Winding Material	Copper
Flux Density	1.0 T
Former Material	Glass Fibre
Winding Depth	16.5 mm (0.65 in)
Magnetic Gap Depth	8.0 mm (0.31 in)

SPECIFICATIONS HF UNIT

Sensitivity ⁵	105.0 dB
Nominal Power Handling ⁶	80 W
Continuous Power Handling ⁷	160 W
Voice Coil Diameter	75 mm (3.0 in)
Winding Material	Aluminium
Flux Density	1.6 T
Diaphragm Material	Titanium
Recommended Crossover ⁸	1.2 kHz
Inductance	0.14 mH

B&C Speakers s.p.a.

Via Poggiomoro, 1 - Loc. Vallina, 50012 Bagno a Ripoli (FI) - ITALY - Tel. +39 055 65721 - Fax +39 055 6572312 - mail@bcspeakers.com

PARAMETERS

Resonance Frequency	40 Hz
Re	5.2 Ω
Qes	0.47
Qms	8.3
Qts	0.44
Vas	187.0 dm ³ (6.6 ft ³)
Sd	855.0 cm ² (132.5 in ²)
η_e	2.5 %
Xmax	\pm 6.5 mm
Xvar	\pm 7.5 mm
Mms	87.0 g
Bl	15.6 Txm
Le	1.2 mH
EBP	85 Hz

MOUNTING AND SHIPPING INFO

Overall Diameter	393 mm (15.5 in)
Bolt Circle Diameter	374 mm (16.7 in)
Baffle Cutout Diameter	353 mm (13.9 in)
Depth	199 mm (7.83 in)
Flange and Gasket Thickness	16 mm (0.62 in)
Net Weight	9.0 kg (19.8 lb)
Shipping Units	1
Shipping Weight	10.6 kg (23.37 lb)
Shipping Box	500x495x275 mm (19.69x19.49x10.83 in)

CROSSOVER**SERVICE KIT**

LF recone kit	RCK15FCX768
MF replacement diaphragm	MMD3BTN8M

1. Included by -6 dB down points.
2. Applied RMS Voltage is set to 2.83V.
3. 2 hours test made with continuous pink noise signal within the range Fs-10Fs. Power calculated on rated minimum impedance. Loudspeaker in free air.
4. Power on Continuous Program is defined as 3 dB greater than the Nominal rating.
5. Applied RMS Voltage is set to 2.83V.
6. 2 hour test made with continuous pink noise signal within the range from the recommended crossover frequency to 20 kHz. Power calculated on rated minimum impedance. Loudspeaker in free air.
7. Power on Continuous Program is defined as 3 dB greater than the Nominal rating.
8. 12 dB/oct. or higher slope high-pass filter.